

KOMATSU

WA485-11 wheel loader



Photo may include optional equipment

Net horsepower

362 HP (270 kW) @ 1,600 rpm

Operating weight

61,432-64,992 lbs. (27,865-29,480 kg)

Bucket capacity

6.4-7.2 yd³ (4.9-5.5 m³)

WA485-11

Komatsu – taking our wheel loaders to the next level of performance and economy

Net horsepower

362 HP (270 kW) @ 1,600 rpm

Operating weight

61,432-64,992 lbs. (27,865-29,480 kg)

Bucket capacity

6.4-7.2 yd³ (4.9-5.5 m³)



Photo may include optional equipment

Note:

New features are indicated by a green plus sign (+)

Upgraded features are indicated by a blue plus sign (+)

Economy and productivity

- Komatsu Hydraulic Mechanical Transmission (KHMT) helps control fuel consumption and enhances operation
- Up to 12% lower fuel consumption +
- 21% higher engine power +
- 20% increase in breakout force +
- 18% increase in lifting force +
- 13% increase in climbing speed +
- Bucket redesigned for high efficiency

Easy operation +

- Independent work equipment control
- Travel speed control dial
- Auto hill holding function
- Automatic digging system
- Max power switch

Convenience features +

- Spacious cab for large-size lunchbox
- LED headlamps and work equipment lights
- Save operator preferences and settings

Durability and reliability

- Komatsu next generation engine +
- High rigidity frame and loader linkage +
- Komatsu components engineered for dependability

Operator environment +

- Angle feedback joystick steering (AFJS)
- Newly designed cab with more glass area for increased visibility
- Command selector designed for intuitive operation
- Heated and ventilated premium seat
- 5-way adjustable console and integrated switches
- High definition LCD machine monitor
- Electric adjustable side mirrors with heat
- Window roll curtain

Assisting operator awareness

- Rear object detection system (RODS) +
- Rear view monitoring system
- Adjustable dynamic braking with KHMT +
- Deluxe LED light package +
- Two independent brake systems +

Easy maintenance

- Long oil change intervals +
- Powered tiltable engine hood +
- Improved maintainability for air conditioner and radiator
- Designed to help control downtime +

Information and communication technology (ICT)

- Telematics data available through Komtrax and My Komatsu
- Operator ID with saved preferences +
- Auto idle shutdown

**all comparisons are to the previous Komatsu WA480-8 model unless otherwise noted*

WA485-11 yard loader

Purpose-built yard loader configuration available

Built for demanding quarry and aggregate applications

The new WA485-11 yard loader is designed as a 3-pass match option for loading aggregate and other processed materials into on-highway trucks. It is also adaptable for use in infrastructure, forestry, and non-residential construction applications.

Advantages

- Engineered to drive productivity
- 3 pass for loading on highway trucks

Heavier yard loader counterweight for enhanced stability

Additional frame reinforcement added for durability

New, heavy-duty axles, and 775/65 R29 low profile, wide tires for stability

Photo may include optional equipment

WA485-11 yard loader

Quick specs

Bucket capacity	7.2 yd ³ (5.5 m ³)
Bucket type	Straight
Cutting edge type	Bolt-on edge
Operating capacity	20,613 lbs. (9,350 kg)
Material density at 100% fill factor	2,865 lb/yd ³ (1,700 kg/m ³)
Dumping clearance at 45°	9' 96" (3,035 mm)
Dumping reach at 45°	5' 25" (1,600 mm)
Operating weight	62,082 lbs. (28,160 kg)

Static tipping load	Straight	49,053 lbs. (22,250 kg)
	Full turn	41,998 lbs. (19,050 kg)
Overall length (bucket on ground)		31' 43" (9,580 mm)
Overall height		11' 61" (3,540 mm)
*Overall height ROPS (ISO3471) cab		11' 48" (3,500 mm)
Treads (front and rear)		7' 55" (2,300 mm)
Tire size		775/65R29(L3)
Additional counterweight		1,345 lbs. (610 kg)



Newly optimized
7.2 yd³ (5.5 m³)
Komatsu bucket

Economy and productivity

Newest generation Komatsu engine- U.S. EPA tier 4 Final emissions compliant that is designed to lower fuel consumption, and drives more power and torque at lower speeds +

The basic engine structure has been completely redesigned using Komatsu's proprietary technology for exceptional performance in combustion and exhaust gas after-treatment systems. The diesel particulate filter maintenance has been extended, and the exhaust gas recirculation (EGR) has been eliminated. This revamped engine is designed for ease of maintenance, helping to support sustainability goals and control the total cost of ownership.

Aftertreatment

Aftertreatment is newly designed to meet the latest engine emission requirements through new compact U-shaped design. This aftertreatment is optimized for the new engine and is engineered to provide passive and active regeneration without interrupting machine operation.

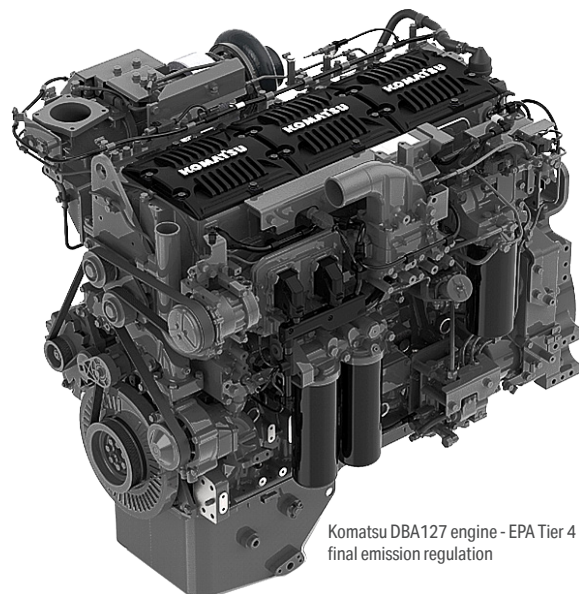

Komatsu DBA127 engine - EPA Tier 4 final emission regulation

Selective catalytic reduction (SCR)

Komatsu Diesel Particulate Filter (KDPF)

Fixed geometry turbocharger

- Tuned injection control
- Advance injection timing (to lower fuel consumption)
- Exhaust gas recirculation (EGR) required

Common rail fuel injection system/200 MPa

Critical components and wear parts redesigned to help promote longevity

Engine controller: CM2450/ECM

Redesigned combustion chamber

Oil mist separator is maintenance free

New cylinder head cover

New

Improvement or reinforcement

New combustion chamber

The newly developed piston combustion chamber shape is designed to promote fuel efficiency while minimizing potentially harmful substances, such as graphite.

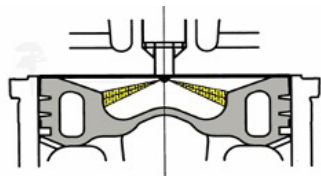

High pressure common rail (HPCR) fuel injection system

The computer controlled HPCR system delivers pressurized fuel in precise quantity into the engine combustion chamber using multiple injections to promote complete fuel burn and help reduce exhaust emissions. The fuel injector life has been redesigned with ultra-hard wear-resistant material such as diamond-like carbon. To account for increased fuel injection pressure (compared to the previous engine model) high pressure fuel lines, brackets and common rail have been integrated into the design. This redesigned engine offers exceptional fuel consumption performance with the added benefits of leakless-style fuel injectors.

	WA485-11	WA480-8
Fuel injection pressure	220 MPa	200 MPa
Fuel injector static leak	Less	—

Komatsu Hydraulic Mechanical Transmission (KHMT)

Continuously variable transmission designed for high efficiency

The KHMT consists of mechanical transmission and hydrostatic transmission (HST). By changing the displacement of the HST pump, the engine speed can be maintained at a lower RPM. By changing the displacement of the HST motor, the transmission can perform stepless shifting. The pump and motor can be switched depending on the optimal situation. Combining HST and the mechanical transmission allows for both excellent controllability and high transmission efficiency, promoting low fuel consumption.

Up to **25% better fuel efficiency** in v-cycle and up to **28% better fuel efficiency** in load and carry*

*compared to Komatsu WA480-8

Crankcase ventilation

The oil mist separator is installed to separate oil from the blow-by gas, which is a mixture of oil and gas emitted from the crankcase to the outside.

The previous filter-based system has been replaced with a hydraulic-driven (using main gallery pressure) centrifugal separation system, promoting maintenance ease.

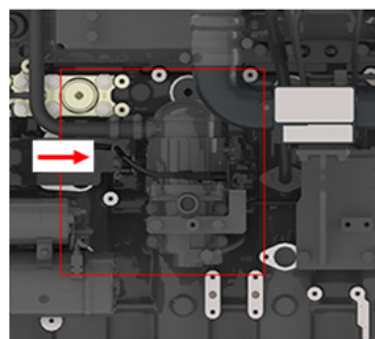

Solid critical engine components

Key engine components such as cylinder blocks, crankshafts, and pistons were reviewed from the viewpoint of materials and structure. The result is significant advancements in material strength, fuel efficiency, long engine life, exceptional engine output and efficient fuel consumption.

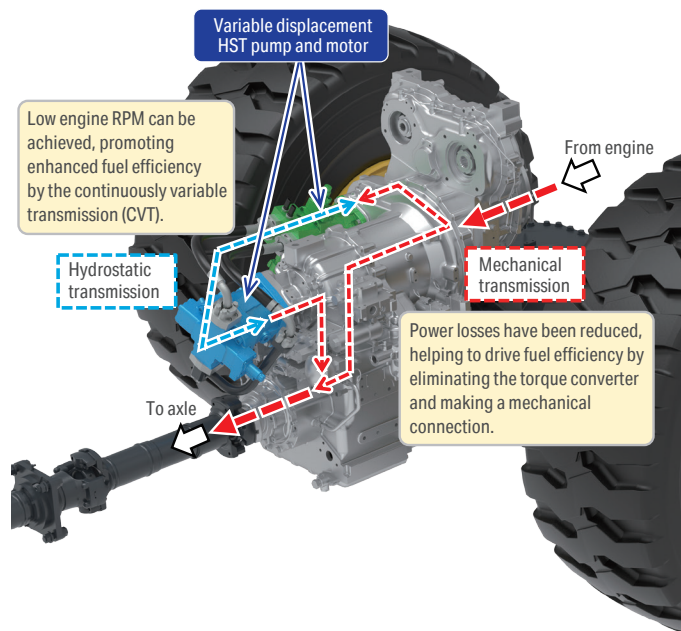

Optimized control system of KHMT +

KHMT's control system comprehensively assesses the work situation through control of power distribution, synchronizing low fuel consumption at low engine speed while providing superior acceleration performance. The optimized system is designed to provide lower noise level while heavy digging and loading. This control system also contributes to machine longevity.

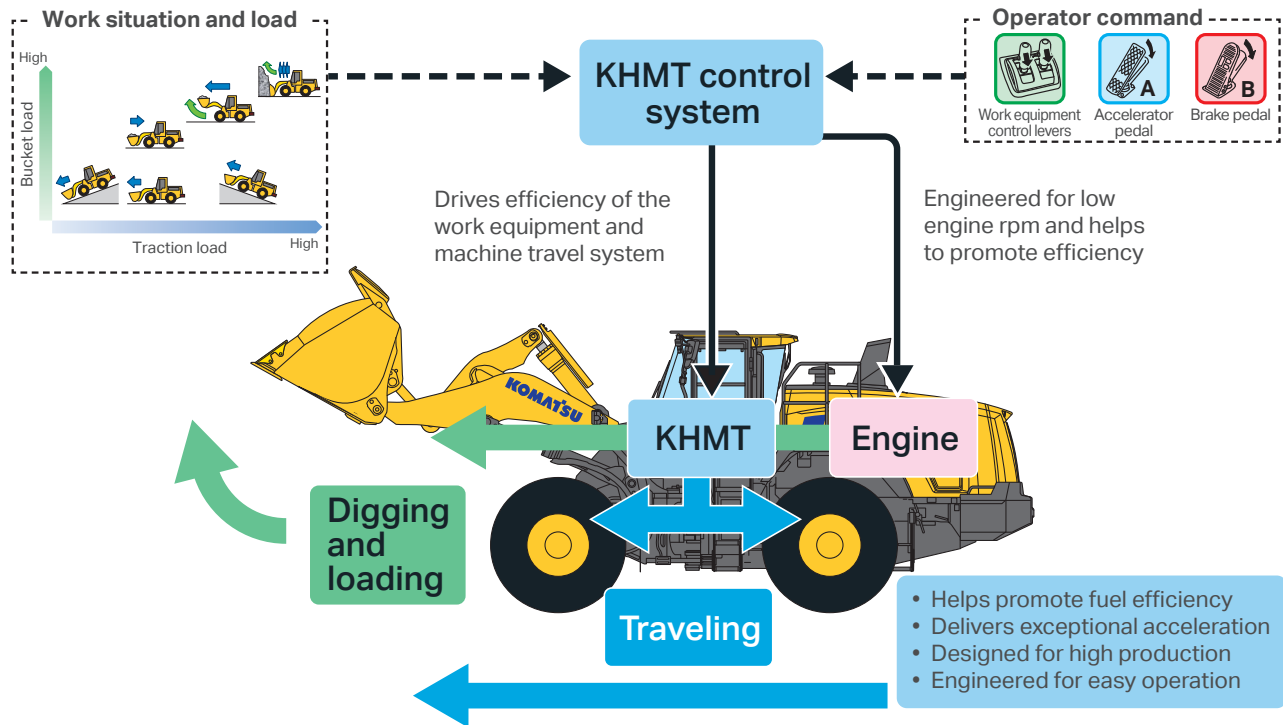

Climbing performance

Increasing uphill speed.

The WA485-11 is equipped with the new DBA127 engine, which significantly contributes to output. As a result, the slope climbing speed is increased by up to 40%*

*compared to WA480-8, in P-mode on concrete road surface, 6° uphill

Uphill speed (mph/km/h)*	WA485-11	WA480-8
6 degree (no load)	13 mph (20.3 km/h) (+13%)	11 mph (18 km/h)
10 degree (no load)	8 mph (13 km/h) (+9%)	7 mph (12 km/h)

Standard limited-slip differential (LSD)

LSD helps create traction and control tire slippage. This can augment the machine's performance in challenging terrain such as sand or weather conditions such as rain and snow. The benefits can also be realized on normal ground conditions by controlling tire slip for excavating and scraping applications. Fuel economy is impacted by controlling unnecessary acceleration while the service life of tires is extended.

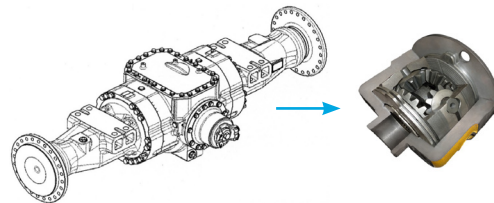

High-performance bucket for superior digging +

The bucket's optimized cross-sectional shape is designed for digging efficiency. The material is scooped up as it is rolled up along the inclined floor of the bucket. The combination of this redesigned bucket and the auto digging system can help boost productivity.

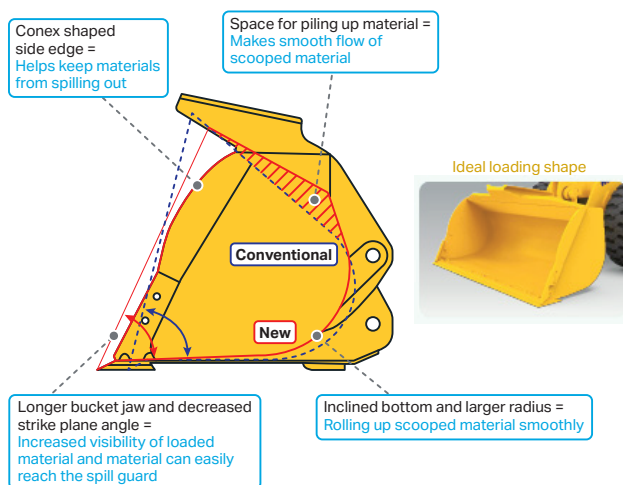

Breakout force (by lift cylinder) +

The breakout force has increased by 20% compared to WA480-8. This performance improvement can help to enhance productivity.

+20%



Increased climbing speed

The climbing speed has been increased along with the higher engine output.

+13% increase in climbing speed

*compared to WA480-8.
In P mode on concrete road surface, 6° uphill

High function load meter +

The standard load meter has enhanced measurement accuracy and added convenient functions. This helps deliver loading weight accuracy for operators, which promotes jobsite efficiency.

Automatic measurement function

This allows the boom to automatically measure with the push of a button. The boom rises at a speed suitable for measuring, promoting an easy, precise number.

Dump monitoring function

If the bucket becomes overloaded, the material amount can be adjusted in real time via a cab monitor. This makes it possible to load an appropriate amount onto a truck efficiently.

Makes calibration easier

Calibration with no load can be easily done by simply pressing an automatic measurement switch for two seconds or more before starting work each day or in between tasks for weighing accuracy. Calibration with load has also been simplified by using on-site sediment and truck scales. Needing to use dedicated calibration weights is made obsolete.

Max power switch +



If the max power switch is pressed while the traction control is ON, setting of the traction control is temporarily canceled and the traction force increases. In addition, when the max power switch is pressed during "e-mode," the "power mode" provides increased traction force. Setting of the traction control and power mode are restored when the max power switch is pressed again or the directional lever is moved. This switch is useful when large traction force is needed during pile-up work or when traveling uphill.



Easy operation

Independent work equipment control +

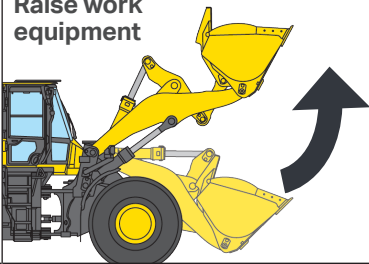
The speed of the work equipment can be controlled using only the operating lever. The engine speed is optimized according to the operation of the work equipment lever without pressing the accelerator pedal.

Operation	<p>Raise work equipment</p> 
WA485-11	<p>Only operation of work equipment control levers</p> <p>Control speed by lever angle</p> 
Conventional model	<p>Combined operation of work equipment</p> <p>Control work equipment speed by accelerator</p> 

Easy approach +

The speed of the work equipment is controlled only by a lever, and the machine travel by an accelerator. There is no need to press the accelerator and the brake pedal at the same time. This can help with operator comfort and control compared to a wheel loader with a traditional torque converter.

Travel speed control dial +

The maximum travel speed can be adjusted with the travel speed control dial. It is effective for V-shape loading, flat ground driving, and downhill driving, reducing the burden on the operator to control vehicle speed.

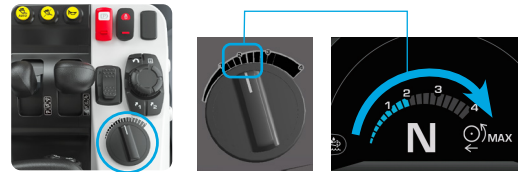

Downhill operation

The travel speed can be adjusted using a control dial. This is designed to allow the machine to travel downhill at a constant speed, while controlling the load from spilling over the bucket. This is also designed to prevent the brakes from overheating.

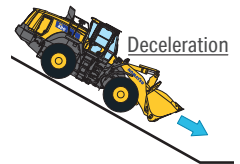

Auto hill holding function +

Auto hill holding function is designed to prevent the vehicle from sliding downhill even if operator doesn't apply the brakes on a slope. This can be effective for piling up work and makes the loader operation easier while helping to lessen operator fatigue.

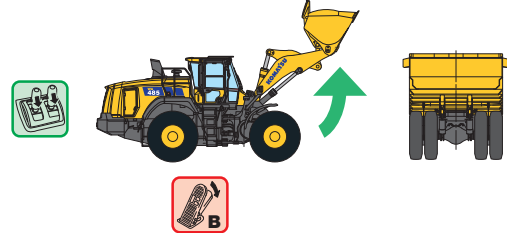
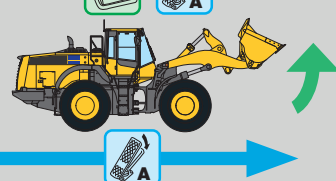
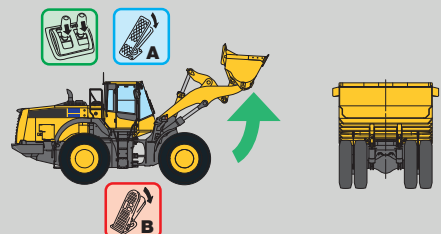

Operation	Boom raising and travel	Approach dump truck
<p>Work equipment operation</p> <p>WA485-11</p> <p>Travel operation</p>		
<p>Work equipment operation</p> <p>Conventional model</p> <p>Travel operation</p>	<p>Combined operation of levers and accelerator</p> 	

Remote boom positioner

The operator can set the bucket angle and remote boom positioner from the cab. Once the positioner is set, the bucket is smoothly stopped at the desired position, helping to promote consistent and easy work.

Automatic digging system +

The new automatic digging system actuates the bucket tilt and lifting operations by detecting the sensing pressure applied to the work equipment. This system can help alleviate operator fatigue and realize an optimized load capacity.

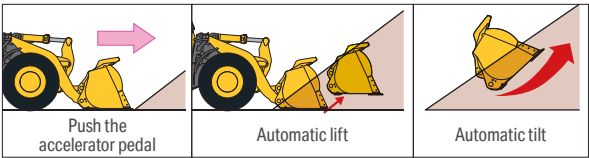

Bucket control switch +

The bucket control switch allows the operator to set the bucket to any angle swing without using the bucket control lever. When the operator presses the bucket control switch, the bucket moves to the set position.



Remote positioner switch



Bucket control switch



Photo may include optional equipment

Operator environment

Newly designed cab +

A pressurized, large, four-pillar cab is designed to provide a quiet operator environment with impressive visibility. Visibility is increased by adding a lower glass area and eliminating the rear pillar. This configuration contributes to comfortable operation together with the newly designed console. In addition, the outside air intake type, fully automatic, large-capacity air conditioner is installed as standard and is engineered to keep the inside of the cab comfortable all year round.

21% increase in front and rear cab glass surface area compared to the previous model for exceptional visibility

Front view



Rear view



Work equipment control levers +

Ergonomically shaped levers and a switching layout that eliminates grip changes helps ease fatigue caused by prolonged operation.



Angle feedback joystick steering (AFJS) +

AFJS is a standard feature that articulates the vehicle body according to the tilt angle of the joystick. Adopting a control system that converts the amount of joystick operation into electrical signals is designed to give this wheel loader a smooth steering feel and lessens operating force, which may reduce wrist strain. Along with exceptional responsiveness, the machine is designed to be intuitive and easy to operate by applying reaction force to the joystick lever. Another common cause of fatigue is lever effort, which has been significantly improved compared to the WA475-10 joystick controls.

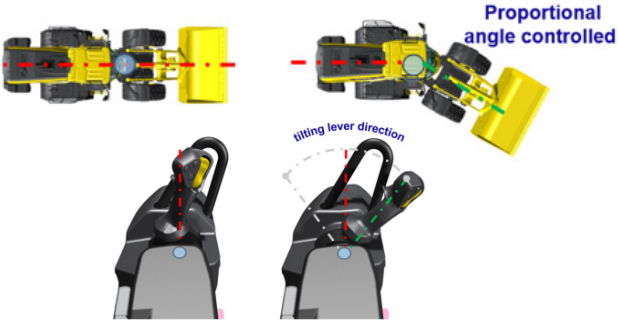

5-way adjustable console and integrated switches +

A new 5-way adjustable console is adopted to suit various types of operator body types. Switches for frequent use during operation are integrated into the right-hand console and front pillar. Operators can access these switches without changing their posture. The switches are equipped with a pilot lamp for enhanced visibility at night.

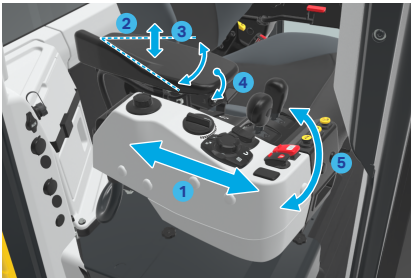

- 1 Console fore/aft
- 2 Armrest height
- 3 Armrest swing+
- 4 Armrest tilt+
- 5 Console tilt+

New steering wheel (optional) +

The operator can easily adjust the steering column angle with a pedal. The steering column flips up to a storage position, so operators have more room to enter and exit the cab.



Steering telescopic lock lever
Steering tilt lock release pedal

Multifunction audio +

Operators can access AM/FM radio, AUX and Bluetooth wireless connectivity. A hands-free microphone is standard.

Large utility space +

The left side of the cab has a multi-purpose space that includes a drink holder. A large cooler box can be placed on the floor.



Deluxe seat with multiple adjustments and heat/cooling settings +

A deluxe seat with luxurious fabric and genuine leather is provided. This also has a three-stage adjustable heater function with seat and backrest memory settings. A cooler function with three temperature settings for hot days helps keep operators comfortable. When AFJS, is selected, the deluxe seat is automatically enabled.



New and improved digital dashboard +

A high-definition dashboard helps provide easy and intuitive machine adjustments. All information is on one large screen, illuminated with an 8" (20 cm) LCD machine monitor on a newly designed interface.



Electric adjustable mirror with heater +

Heated and power adjustable mirrors can be adjusted with a switch inside the cab.

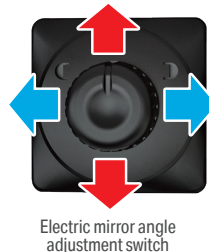

Electric mirror angle adjustment switch

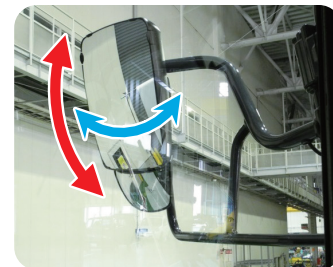

Load meter

The standard load meter has enhanced measurement accuracy to help drive work efficiently.

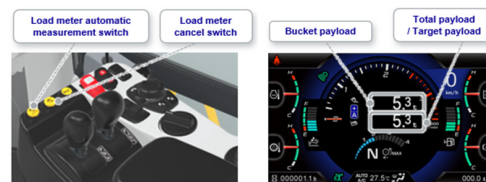

Roll curtain +

A roll curtain is provided above the glass in front of the cab. It can be pulled down when needed to block hot sunlight.





Photo may include optional equipment

Assisting operator awareness

Rear object detection system +

The standard system uses two radars mounted on the rear side of the machine to detect persons, objects and working machines approaching in the direction of travel during reversing. If there is a risk of collision, a warning buzzer and indicator light will alert the operator. False detection reduction functions help maintain uptime while promoting zero harm.

through smart assistance by Komatsu's new

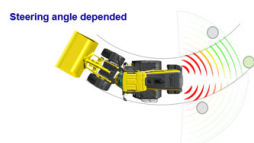
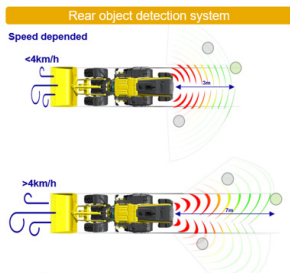

Rearview camera +

The operator can view the rear of the machine with a color monitor screen. The image quality is more advanced than that of previous models.



Color rearview monitor

The 7-inch LCD monitor provides a clear view of the area to the rear of the vehicle. It also includes a switch the operator can use to adjust brightness.



Engine shutdown secondary switch

The engine stop switch is incorporated to allow shutdown of the machine when accessing the key switch is not possible.



Work equipment lock switch

A work equipment lock switch is designed to help prevent accidental operations due to unintentional lever movements.

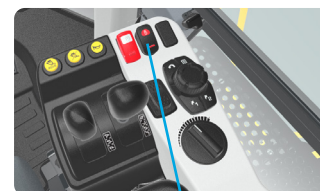

Work equipment lock switch

Secondary steering

Even if the engine stalls, the operator can steer the machine by using the standard auxiliary electric pump.

Two independent brake systems

The brake system is engineered for reliability. It has two independent hydraulic circuits, so there is a backup should one of the circuits fail.

Seat belt caution indicator

A warning indicator on the monitor appears when the seat belt is not engaged.



ROPS/FOPS cab

The ROPS/FOPS cab is standard. The large front curved glass is designed to promote excellent front visibility.



ROPS (ISO 3471):

Roll-over Protective Structure

FOPS (ISO 3449):

Falling Objects Protective Structure

Deluxe LED lighting package +

LED lamps are equipped on various positions of the machine. This helps operators perform in low-light conditions and nighttime operations. The rear combination lamp is recessed into the counterweight to help minimize risk of damage.

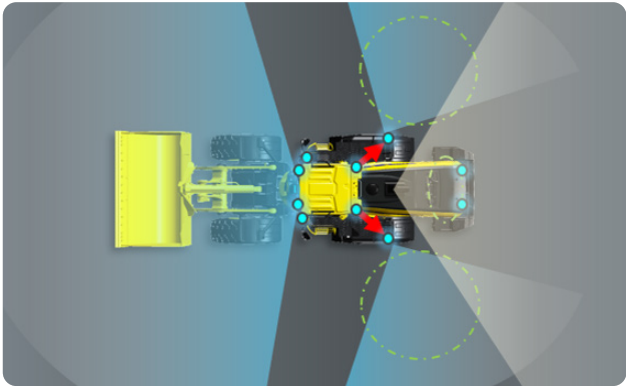

Colored handrails and steps for enhanced visibility +

The handrails are painted a different color from surrounding parts for increased visibility.



High visibility seatbelt +

The vehicle comes standard equipped with a two-point seatbelt in orange. A four-point seatbelt is also available as an option.



Two-point seatbelt



Four-point seatbelt

Wheel chocks

The vehicle is equipped with wheel chocks designed to help prevent unexpected vehicle movement.



Maintenance features

21% reduction in maintenance costs

- Extended change interval for hydraulic oil and oil filter from 2,000 hours to 6,000 hours
- Extended KDPF cleaning interval from 4,500 hours to 8,000 hours

*Compared to WA480-8

Powered tiltable engine hood +

The powered tiltable engine hood has greater maintenance access. An engine hood side cover is provided for daily inspection and maintenance. A special small window is provided to access the air cleaner located in the engine room. The operator can access the engine areas that are serviced every day from left- and right-hand hood side covers.

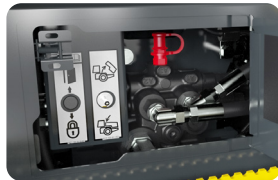

View from the right-hand side of the machine

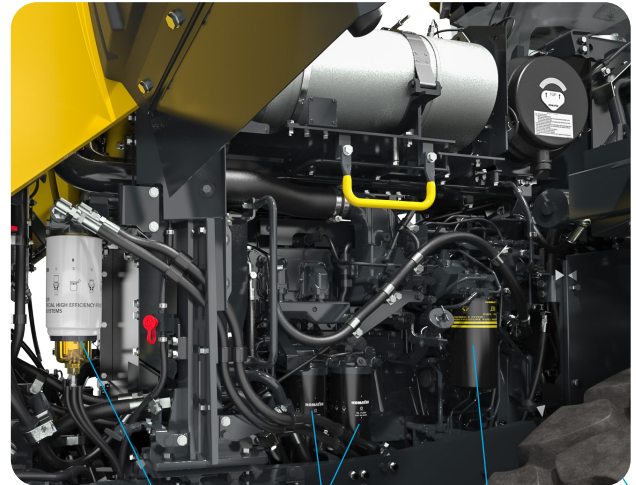

Fuel prefilter

Engine oil filters

Fuel filter

Swing-out type cooling fan

The hydraulic cooling fan swings out and can be opened and closed with a single touch. The radiator can be cleaned from the rear as well.

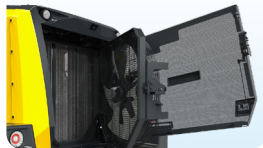

Auto reversing fan

The engine cooling fan is driven hydraulically. It can be set to reverse automatically during operation. Fan reverse mode and timing can be controlled through the monitor based on application requirements.

Easy window cleaning +

Wide steps, roof handrail and anchor points of tie-off are installed. It is designed for easy window cleaning.



Roof handrail



Anchor point of tie-off



Steps



Minimize downtime +

The aftertreatment devices and engine can be easily replaced by opening the engine hood. In addition, the cab can be easily removed as well. Moreover, the air conditioner blower motor is also designed to be easier to remove and install than previous models, while the evaporator is easier to clean. These new versatile design enhancements can help reduce servicing downtime over the life of the machine.



Air cleaner +

The air cleaner is located on the right side platform for easy access.



DEF tank

To facilitate easy refilling, the DEF tank is installed near the access and egress ladder on the right-hand side of the vehicle. The chain attached designed to prevent it from falling off when refilling.



Engine hood side covers +

The operator can access daily checks from the engine right-hand and left-hand hood side covers. The side-by-side type radiator can be easily cleaned.



Low maintenance battery

Low maintenance battery helps reduce servicing downtime. Battery status indicators help operators monitor battery health or service needs.

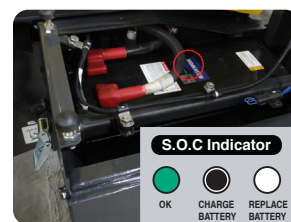

Easy sampling

A sampling port for oil and coolant makes this process simple to manage.



WA485-11



Designed for reliability and durability

High-rigidity frames and loader linkage

The front and rear frames as well as the loader linkage are engineered to have enhanced torsional rigidity that provide increased resistance to stresses. The frames and loader linkage are designed to withstand actual working loads.

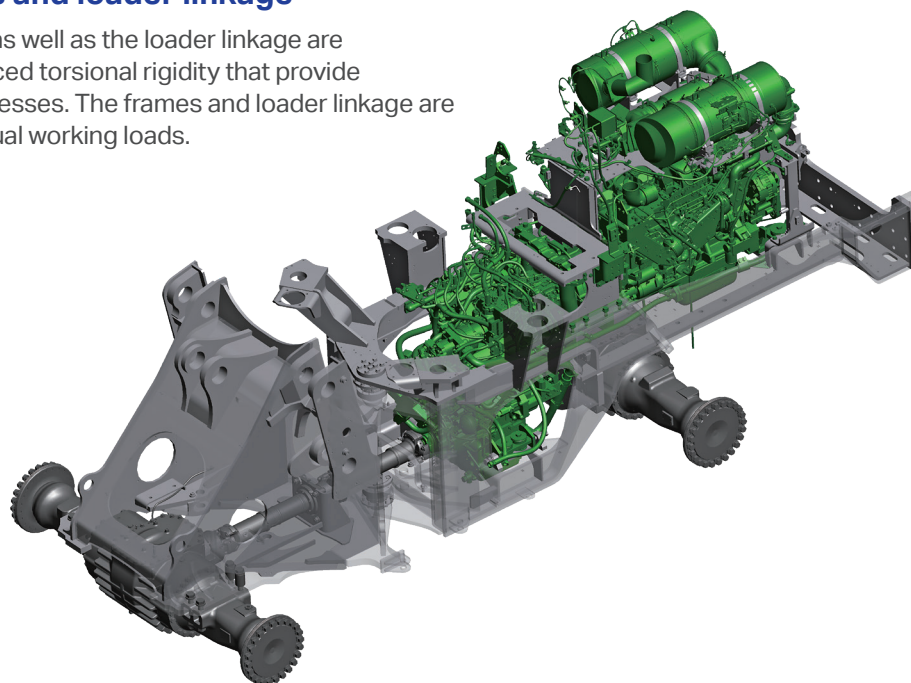

Komatsu components

Komatsu manufactures the engine, hydraulic mechanical transmission, hydraulic units and electric parts on this wheel loader. Komatsu loaders are manufactured with an integrated production system under a strict quality system.

Wet multiple-disc brakes and fully hydraulic braking system

Wet multiple-disc brakes are fully sealed and designed to keep contaminants out, helping to control wear and maintenance. Brakes are engineered to require no adjustments for wear, promoting less maintenance costs and enhanced reliability. The parking brake is a wet multiple-disc to help promote reliability and long life. Added reliability is designed into the braking system by the use of two independent hydraulic circuits, providing hydraulic backup should one of the circuits fail.

High quality coating of machine body

High quality coating is applied to the exterior of the machine body. For sheet metal parts, cationic electrodeposition coating is used for the base treatment, and melamine baking coating is used for the topcoat. For plastic parts, urethane coating is used. This helps maintain the beautiful, glossy appearance over time, even in harsh environments.

Flat face-to-face O-ring seals

O-ring face seals are engineered for high sealing performance and are used for hydraulic piping joints.

Sealed connectors

Main harnesses and controller connectors are equipped with sealed connectors helping to promote high reliability, water resistance and dust resistance.

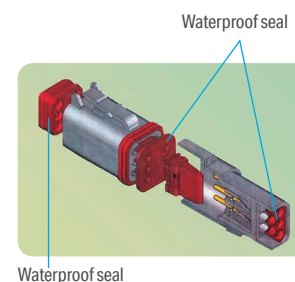

Komatsu helps you bring it all together

Get the most out of your fleet with My Komatsu

We've designed a portal that makes it easy to collect, visualize and monitor data for both Komatsu machines and other OEM machines. My Komatsu also gives you one easy source for accessing manuals and purchasing parts for your machines.

- Quickly collect, view and manage intuitive data displays in one location
- Help keep costs under control
- Benchmark machine performance and track fuel consumption
- Monitor for theft and unauthorized use
- Receive timely maintenance alerts

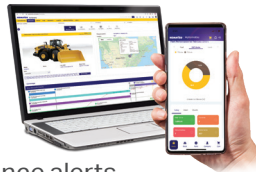

My Komatsu, our comprehensive portal, analyzes telematics data from your on-machine technology — Komtrax, Komtrax Plus or from other OEMs — and displays it on easy-to-read dashboards. Now you can get the powerful analytics you need to manage your costs and enhance your fleet's efficiency without a complicated process or expensive third-party solutions.



Data
Telematics data is generated by on-machine technology.



Storage
Telematics data flows into data storage. ISO 15143-3 (AEMP 2.0) facilitates the extraction and raw data to your choice of databases.



Connection
Choose how you want to connect and view your data. Go to multiple systems, send to a third party or easily connect it all through My Komatsu.



Analytics
My Komatsu connects telematics data from Komatsu and non-Komatsu equipment and creates powerful analytics dashboard views.

mykomatsu.komatsu

Connect your machines to Smart Construction to optimize your job sites

Your projects depend on robust data that is easily shared, replicated, updated and — most important of all — correct.



Take a step toward a digital transformation of your job sites with Komatsu's suite of Smart Construction solutions, where advanced automation and integrated technologies intersect to help you:

- Track costs of labor, machines and materials
- Receive real-time insights straight from the field
- Enhance workflow with fully integrated data
- Visualize your data for actionable results
- Quickly map your job site
- Attract and retain talent



Not sure where to begin? Komatsu-certified solution experts are available on the phone, online or at your job site to help you navigate and thrive along your digitalization journey.

komatsu.com/smart-construction

Komatsu maintenance and repair programs

Get the service and repairs you need your way. Komatsu offers a tiered maintenance and repair program that simplifies the upkeep of your machine to help control operating costs and get the most from your equipment. Manage your active coverage programs through the My Komatsu customer interface and take advantage of attractive financing options.

- Solutions that fit your needs and ease your mind
- Fixed maintenance and repair costs for the life of the contract
- National coverage

Komatsu Care Complimentary

Complimentary maintenance

Our complimentary scheduled maintenance program for the first three years or 2,000 hours, whichever occurs first.

Komatsu Care Plus

Extended maintenance

A continuation of the Komatsu Care program. Along with regularly scheduled maintenance and national distributor coverage, you get a variety of added benefits.

Komatsu Care Plus II

Extended maintenance and repair

Everything in the Komatsu Care Plus program bundled with comprehensive repair coverage for qualifying repairs.

Komatsu Care Plus III

Extended maintenance, repair and consumables

A comprehensive program that simplifies your equipment's total cost of ownership with a fixed cost per hour for qualifying repairs and replacements.

Komatsu Care Advantage Warranty

Extended warranty

Protect your equipment in the event a covered component fails due to a defect in material or workmanship. Repairs are performed by Komatsu-trained experts using Komatsu genuine parts.

komatsu.com/maintenance-repair

Komatsu Financial

Financing can be a major advantage for your operation, enabling you to get the equipment and service you need with terms to fit your business needs. Komatsu Financial offers services built for your business success.

komatsu.com/financing

Komatsu Genuine Parts

Engineered to help extend the life of your Komatsu machine. Now available on the My Komatsu parts store.

komatsu.com/parts

Komatsu training

Comprehensive training support — virtually, at our facility or where most convenient.

komatsu.com/training



Buckets and attachments

Buckets

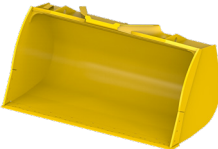
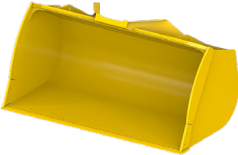
Type	Feature	Image
Stockpile bucket	This bucket is used for loading stockpile products, such as crushed rock and construction materials.	
Loose/light material bucket	This bucket is used for loading materials with comparatively light specific gravity. It is based on the general purpose bucket, with a lengthened cutting edge and width to give increased capacity.	



Dimensions

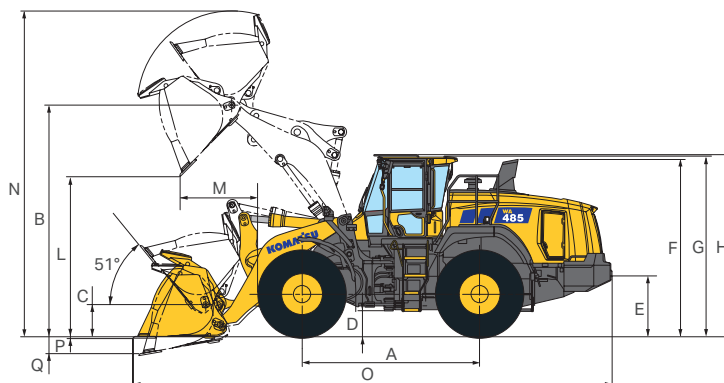
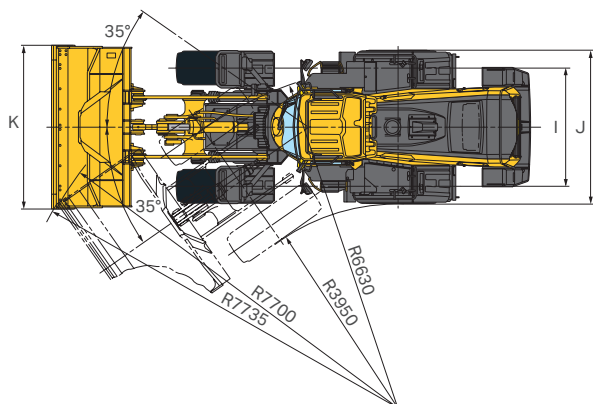

Standard boom, straight edge, bolt on cutting edge

		Standard spec Stock pile bucket	Yard loader spec Loose material bucket**
Bucket capacity	Heaped ISO rated	6.4 yd ³ (4.9 m ³)	7.2 yd ³ (5.5 m ³)
	Heaped 110% fill factor	7.1 yd ³ (5.4 m ³)	8.0 yd ³ (6.1 m ³)
	Struck	5.5 yd ³ (4.2 m ³)	6.1 yd ³ (4.7 m ³)
A	Wheelbase	11' 4" (3,450 mm)	11' 4" (3,450 mm)
B	Hinge pin height, max. height	14' 9" (4,500 mm)	14' 9" (4,500 mm)
C	Hinge pin height, carry position	2' 1" (630 mm)	1' 11" (595 mm)
D	Ground clearance	1' 8" (505 mm)	1' 8" (505 mm)
E	Hitch height	3' 11" (1,200 mm)	3' 11" (1,200 mm)
F	Overall height, top of the stack	11' 4" (3,450 mm)	11' 4" (3,450 mm)
G	Overall height, ROPS cab	11' 6" (3,500 mm)	11' 6" (3,500 mm)
H	Overall height, top of the roof rail	11' 7" (3,540 mm)	11' 7" (3,540 mm)
I	Tread	7' 6" (2,300 mm)	7' 6" (2,300 mm)
J	Width over tires	10' .5" (3,060 mm)	10' .5" (3,060 mm)
K	Bucket width	10' 5" (3,170 mm)	10' 5" (3,170 mm)
	Bucket weight	5,478.5 lbs. (2,485 kg)	5,699 lbs. (2,585 kg)
L	Dumping clearance, max. height and 45° dump angle*	10' 3" (3,115 mm)	9' 11" (3,025 mm)
M	Reach at max. height and 45° dump angle*	4' 11" (1,510 mm)	5' 3" (1,600 mm)
	Reach at 6' 11.8" (2,130 mm) clearance and 45° dump angle*	7' 2" (2,195 mm)	7' 4" (2,245 mm)
	Reach with arm horizontal and bucket level*	10' 4" (3,150 mm)	10' 9" (3,280 mm)
N	Operating height (fully raised)	20' 9" (6,335 mm)	20' 9" (6,315 mm)
O	Overall length	30' 7" (9,315 mm, with BOC)	31' 5" (9,575 mm, with BOC)
	Loader clearance circle diameter (bucket at carry, outside corner of bucket)	25' 4" (7,735 mm)	25' 6" (7,765 mm)
P	Digging depth: 0°	1.2" (30 mm)	1.2" (30 mm)
Q	Digging depth: 10°	1' 3" (375 mm)	1' 3" (395 mm)
	Static tipping load Straight	47,157 lbs. (21,390 kg)	48,954 lbs. (22,205 kg)
	Static tipping load 40° full turn	40,499 lbs. (18,370 kg)	41,921 lbs. (19,015 kg)
	Breakout force	207 kN (21,116 kg)	192 kN (19,543 kg)
	Operating weight	61,432-64,992 lbs. (27,865-29,480 kg)	61,432-64,992 lbs. (27,865-29,480 kg)

Specifications

Engine

Model	Komatsu DBA127
Type	Water-cooled, 4-cycle
Aspiration	Turbocharged, aftercooled
Number of cylinders	6
Bore x stroke	5.1" x 6.3" (130 mm x 160 mm)
Piston displacement	3.37 gal (12.74 L)
Governor	All-speed, electronic
Horsepower	
SAE J1995	Gross 271 kW 363 HP
ISO 14396	271 kW 363 HP
ISO 9249/SAE J1349*	Net 270 kW 362 HP
Rated rpm	1600 min ⁻¹
Fan drive method for radiator cooling	Hydraulic
Fuel system	Direct injection
Lubrication system:	
Method	Gear pump, force-lubrication
Filter	Full-flow type
Air cleaner	Dry type with double elements and dust evacuator, plus dust indicator

* Net horsepower at the maximum speed of radiator cooling fan is 259 kW 347 HP. U.S. EPA Tier 4 Final and EU Stage V emissions certified.

Transmission

Type	Hydraulic Mechanical planetary type
Travel speed	
Measured with 26.5R25 tires	
Forward	1.9-23.6 mph (3.0-38.0 km/h)
Reverse	1.9-17.4 mph (3.0-28.0 km/h)

Axles and final drives

Drive system	Four-wheel drive
Front	Fixed, semi-floating
Rear	Center-pin support, semi-floating, 26° total oscillation
Reduction gear	Spiral bevel gear
Differential gear	Conventional type
Final reduction gear	Planetary gear, single reduction

Brakes

Service brakes	Hydraulically actuated, wet multiple-disc brakes actuate on four wheels
Parking brake	Wet multiple-disc brake
Secondary brake	One of dual service brake circuits is commonly used.

Weight and dimension changes

Applying the following weight and dimensions changes to operating weight, static tipping load, width over tires and overall length.

Tires or attachments	Operating weight	Tipping load		Width over tires	Overall length
		Straight	Full turn		
775/65R29(L-3)	+1,929 lbs. (875 kg)	+1,312 lbs. (595 kg)	+1,157 lbs. (525 kg)	+6.1" (155 mm)	0" (0 mm)
With additional counterweight*	+1,345 lbs. (610 kg)	+3,188 lbs. (1,446 kg)	+2,652 lbs. (1,203 kg)	0" (0 mm)	+5.3" (135 mm)

* "With additional counterweight" does not apply for aggregate specification because the aggregate specification includes additional counterweight.

Steering system

Type	Articulated type, full-hydraulic power steering
Steering angle	35° each direction (40° end stop)
Minimum turning radius at the center of outside tire	21' 9" (6,630 mm)

Hydraulic system

Steering system:	
Hydraulic pump	Piston pump
Capacity	41.7 gal/min (157.7 L/min)
Relief valve setting	3,555 psi (24.5 MPa 250 kgf/cm ²)
Hydraulic cylinders:	
Type	Double-acting, piston type
Number of cylinders	2
Bore x stroke	3.7" x 1' 5" (95 mm x 441 mm)
Loader control:	
Hydraulic pump	Piston pump
Capacity	88 gal/min (333 L/min)
Relief valve setting	5,120 psi (35.3 MPa 360 kgf/cm ²)
Hydraulic cylinders:	
Type	Double-acting, piston type
Number of cylinders – bore x stroke:	
Lift cylinder	2 – 5.9" x 2' 8" (150 mm x 818 mm)
Bucket cylinder	1 – 7.1" x 2' 1" (180 mm x 621 mm)
Control valve	2-spool type
Control positions:	
Boom	Raise, hold, lower, and float
Bucket	Tilt-back, hold, and dump
Hydraulic cycle time (rated load in bucket)	
Raise	6.1 s
Dump	2.1 s
Lower (Empty)	3.2 s

Service refill capacities

Cooling system	17.4 gal (66 L)
Fuel tank	94.8 gal (359 L)
Engine	10.8 gal (41 L)
Hydraulic system	34.9 gal (132 L)
Axle front	14.9 gal (56.5 L)
rear	14.9 gal (56.5 L)
Transfer case	10.6 gal (40 L)
DEF tank	15.9 gal (60 L)

Bucket selection guide

The size and type of the bucket should be properly selected depending on the density of the material and the expected bucket fill factor. Depending on the conditions, Komatsu buckets may perform more than rated capacity thanks to powerful boom linkage, efficient bucket shape and high rimpull.

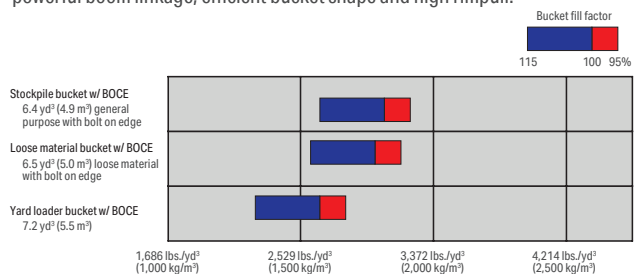

Equipment

Engine

Engine, Komatsu DBA127	●
Komatsu Diesel Particulate Filter	●
Alternator, 24 V/140 A	●
Starting motor, 24 V/11.0 kW	●
Maintenance free batteries, 2 x 12 V / 136 A	●
Engine air intake pre-cleaner with extension	●

Cab

Seat, air suspension type with reclining	●
Seat mounted 5-way adjustable console right-hand	●
Electronic pilot control fingertip control with directional selector switch, two levers	●
Multifunction mono-lever loader control with transmission F-N-R switch	○
ROPS/FOPS (ISO 3471/ISO 3449) cab	●
High-definition color monitor	●
Angle feedback joystick steering (AFJS)	●
Steering wheel, tilttable, telescopic	○
Auto air conditioner	●
Multifunction audio	●
DC12 V electrical outlets	●
Floor mat	●
Rain visor	●
Rear defroster (electric)	●
Front wiper (with washer and intermittent)	●
Machine monitor with trouble shooting function	●
Rear window washer and wiper	●
Seat belt	●
Large utility space	●
Cup holder	●

Lighting system

Rear working lamps on grill, LED, L.H. and R.H. side, 2 lamps	●
Rear working lamps, LED, L.H. and R.H. side, 2 lamps	●
Additional rear working lamps on platform, LED, L.H. and R.H. side, 2 lamps	●
Front working lamps, LED, L.H. and R.H. side, 4 lamps	●
Side working lamps, LED, L.H. and R.H. side, 2 lamps	●
Stop and tail lamps, LED and turn signal lamps	●
Headlamps, LED, L.H. and R.H. side	●
Directional signal	●
Hazard lamps	●
Back-up lights, LED	●

Safety equipment

Service brakes, wet disc type	●
Back-up alarm	●
Electric controlled mirrors with heater	●
Rearview monitoring system	●
Horn, electric	●
Parking brake, electric	●
Anchorage points for tie off	●
Handrails for platform	●
Handrails for roof	●
Front frame step for cleaning window	●
Secondary steering	●
Rear object detection system	●

Tires

26.5R25(L-3)	●
775/65 R29(L-3)	○

Other

Engine shutdown secondary switch	●
Radiator, wide core	●
Radiator mask, swing out	●
Komatsu hydraulic mechanical transmission (KHMT)	●
Loader linkage with standard boom	●
2-spool valve for boom and bucket controls	●
3-spool valve with lever and piping	○
Counterweight, standard	●
Additional counterweight	●
Lift cylinders and bucket cylinder	●
Electronically controlled suspension system	●
Remote bucket positioner, in-cab adjustable, 3 positions	●
Remote boom positioner, in-cab adjustable	●
Auto idle stop timer setting	●
Auto shift control	●
Battery disconnect switch	●
Hydraulic-driven fan with automatic reverse rotation	●
Vandalism protection	●
Front fenders with extensions	●
Rear full fenders	●
Komtrax	●
ECO guidance	●
Fuel pre-filter with water separator	●
Cutting edge (bolt on type)	○
Limited slip differential (front and rear)	●
Various bucket options	○
Various tire options	○

Standard equipment	●
Optional equipment	○

Product designs, specifications and/or data in this document are provided for informational purposes only and are not warranties of any kind. Product designs and/or specifications may be changed at any time without notice. The only warranties that apply to sales of products and services are Komatsu's standard written warranties, which will be furnished upon request.

Komatsu and other trademarks and service marks used herein are the property of Komatsu Ltd. or its subsidiaries, or the respective owners or licensees.

KOMATSU

[komatsu.com](https://www.komatsu.com)

